

BDM-800

Installation User Manual

Northern Electric Power Co., Ltd.

V2.1 rev.2024.1.23

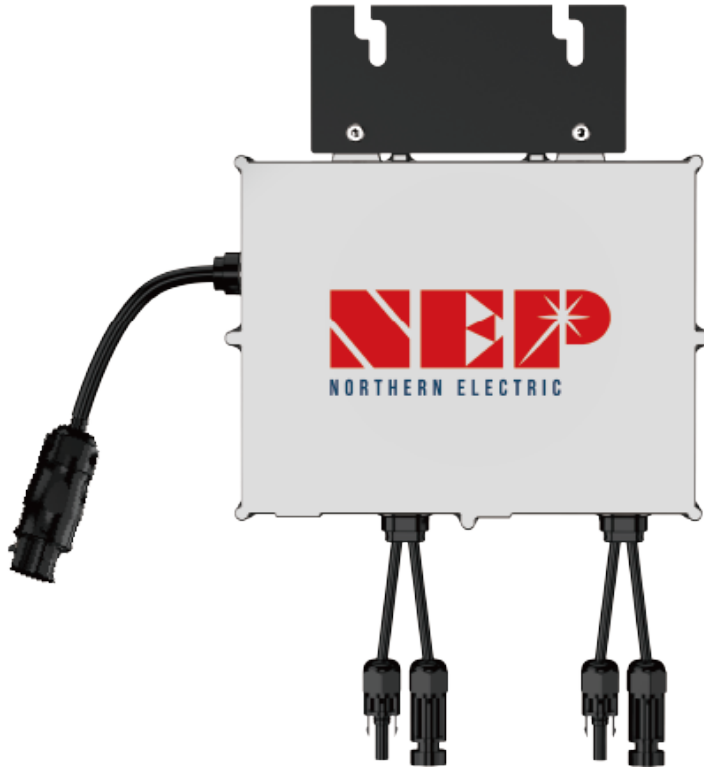

DISCLAIMERS

The information in these documents is the property of Northern Electric Power Co., Ltd., hereafter referred to as NEP.

No part of this document may be reproduced, stored in a retrieval system, or transmitted, in any form or by any means, mechanical, electronic, photographic, magnetic or otherwise, without the prior written permission of NEP. Internal reproduction used solely for the purpose of product evaluation or other proper use is allowed and does not require prior approval.

NEP makes no representations or warranties, express or implied, with respect to this documentation or any of the equipment and/or software it may describe, including without limiting the generality of the foregoing, to any implied warranties of utility, merchantability, or fitness of any particular purpose. All such representations or warranties are expressly disclaimed. Neither NEP nor its distributors or dealers shall be liable for any indirect, incidental, or consequential damages under any circumstances.

The exclusion of implied warranties may not apply in all cases under some statutes, and thus the above exclusion may not apply.

This document and the material furnished within is believed to be complete, accurate and up-to-date. Readers are cautioned, however, that product improvements and field usage experience may cause NEP to make changes to specifications and contents without prior notice, or per contract provisions in those cases where a supply agreement requires advance notice. NEP assumes no responsibility for the use of this material, and no responsibility for any damages, including indirect, incidental or consequential damages, caused by reliance on the material presented, including, but not limited to, omissions, typographical errors, arithmetical errors or listing errors in the content material.

Specifications and contents in these documents are continually reviewed, and subject to change without prior notice where necessary. However, discrepancies cannot be excluded. No guarantee is made for the completeness of these documents.

NEP WARRANTY

You can download the latest warranty terms and conditions from website at northernep.com.

For technical problems concerning NEP products and requiring assistance, please refer to [CONTACT](#).

Trademarks

All trademarks, including company, brand products and service names, are recognized, even if not explicitly identified as such. Missing designations do not mean that a product or brand is not a registered trademark.

INFORMATION ON THIS DOCUMENT

Target Group

This document is intended for "[Qualified Persons](#)" and "[End Users](#)".

Tasks marked with a warning symbol and the caption "[Qualified Persons](#)" require associated skills to avoid and deal with the dangers and risks in installing and using the product and tools described in this document.

Tasks not marked do not require particular qualifications and skill sets, and therefore can be performed by end users.

Qualified Persons



QUALIFIED PERSONS

Qualified Persons required

Qualified persons are required to be familiar, understand and capable of following all applicable regulations, directives and laws, and are aware of the potential risks to perform the activities marked in this document.

The following knowledge and skills are required for qualified persons:

- Knowledge of how an inverter works and is operated
- Knowledge of all applicable standards and directives, including country-specific grid conditions and regulatory guidelines
- Knowledge and training of how to minimize and deal with dangers and risks associated with using, installing, and repairing electrical devices and installations
- Knowledge and training in the installation and commissioning of electrical devices, especially those associated with PV systems
- Knowledge and training of and compliance with this document and all safety information
- Knowledge of warranty terms and conditions associated with the product described in this document



INFORMATION

"Qualified Person" means he/she is validly licensed from the local authority in:

- Safely and properly installing electrical equipment and PV power systems
 - Safely and properly applying all applicable installation codes in practice
 - Properly analyzing and minimizing the hazards in performing electrical work and finished works for all persons and properties involved
 - Properly selecting and using Personal Protective Equipment (PPE)
-

End Users

End users can be referred to any who intend to use the product described in these documents, and must avoid performing tasks marked in this document with requirement for qualified persons.

End users should use this document for a comprehensive understanding of general features and functions involved in the product, and as a guideline for performing tasks that do not require particular qualifications independently.



WARNING

DO NOT put this product in use unless it has been successfully installed and commissioned by a qualified person following described requirements and steps in the section of [Installation](#) and [Commissioning](#) as well as all applicable laws and safety regulations.

Content and Structure

This document describes the unpacking, mounting, installation, commissioning, startup, operation, troubleshooting, maintenance, as well as the disconnection of the product. Applicable inverter models are listed below:

- BDM-800
- BDM-800WIFI

This document, as well as any data, images and illustrations included herein, are reduced to the essential information for the user's guidance, and therefore deviate from the real product. Update of this document may not be announced.

For the latest version of this document and further information on the described product, please visit website at northernep.com.

For technical problems concerning the products in this document and requiring assistance, please refer to [CONTACT](#).

Copyright © 2021 Northern Electric Power Co., Ltd.. All rights reserved.

Warning Messages

The following warning messages are used in this document, and should be familiarized before installation or operation of the product.

Failure to follow may result in injury, damage to properties, or a fatal event.

DANGER

DANGER denotes a hazardous situation which, if not avoided, will result in death or severe injury.

WARNING

WARNING denotes a hazardous situation which, if not avoided, can result in death or severe or moderate injury.

CAUTION

CAUTION denotes a hazardous situation which, if not avoided, can result in moderate or minor injury.

NOTICE

NOTICE denotes a situation which, if not avoided, that can result in property damage

FCC COMPLIANCE

This equipment has been tested and found to comply with the limits for a Class B digital device, pursuant to part 15 of the FCC Rules. These limits are designed to provide reasonable protection against harmful interference in a residential installation. This equipment generates uses and can radiate radio frequency energy and, if not installed and used in accordance with the instructions, may cause harmful interference to radio communications. However, there is no guarantee that interference will not occur in a particular installation. If this equipment does cause harmful interference to radio or television reception, which can be determined by turning the equipment off and on, the user is encouraged to try to correct the interference by one or more of the following measures:

- Reorient or relocate the receiving antenna.
- Increase the separation between the equipment and the receiver.
- Connect the equipment into an outlet on a circuit different from that to

which the receiver is connected.

- Consult the dealer or an experienced radio/TV technician for help.

Changes or modifications not expressly approved by the party responsible for compliance may void the user's authority to operate the equipment.

SAFETY INSTRUCTIONS

SAVE THESE INSTRUCTIONS

Users of these documents are cautioned to familiarize themselves with safety instructions contained in this section and observe at all time when working.

Users are reminded that all electrical or electronic devices come with residual risks despite compliance with international safety requirements and careful construction. To prevent injury and property damage, and to ensure long-term operation of the product, please adhere to all applicable safety instructions in handling and usage of the product.

DANGER

Danger to life due to electrical shock when live components are touched in opened product

High voltages and energies are present in live components and cables inside the product during operation, e.g. capacitors, connectors. Touching live components and cables may result in death or severe injuries due to electric shock.

- **DO NOT** open the product.
- **DO NOT** touch live components.

DANGER

Danger to life due to electrical shock when live DC cables or components are touched

High DC voltages are present in the DC cables when PV modules are exposed to light. Touching live DC cables or components may result in death or severe injuries due to electric shock.

- **DO NOT** touch non-insulated parts or cables.
- **DO NOT** touch live components when voltage sources are still connected or just disconnected.
- **DO NOT** connect DC connectors to the product under load.

- Personal protective equipment **MUST** be worn suitably and properly for all work on the product and the system.
- Voltage sources **MUST** be disconnected from the product before all work.

DANGER

Danger to life due to electrical shock in case of over-voltages and missing surge protections

Over-voltages may conduct into other properties (e.g. electrical network of the building, connected devices via network cables or data cables) in the event of a flash or lightning strike when there is no surge protection integrated in the system. Touching live product, components and cables may result in death or severe injuries due to electric shock.

- Within the same electrical system and network, make sure all devices are integrated in the range of existing over-voltage protection.
- Integrate suitable surge protection to the transition from any cables, products or conductive component within the system that are laid outdoor to the indoor system.

DANGER

Danger to life due to electrical shock from touching ungrounded components or from touching live components in case of a ground fault

Touching ungrounded PV modules, array frame, inverter or live system component, or parts of the system components that are still live in the event of a ground fault, may result in death or severe injuries due to electric shock.

- PV modules and the array frames, including electrically conductive surfaces, **MUST** be connected and grounded in compliance with all applicable regulations.

In the event of a ground fault,

- **DO NOT** touch any parts or frame of the PV array.
- **DO NOT** touch any cables without reliable insulation.
- **DO NOT** connect the product to any strings with ground faults.
- Before working on the product, voltage resources **MUST** be disconnected.
- Personal protective equipment **MUST** be worn suitably and properly for all work.

WARNING

Risk of Injury from exposure to substances, gases and dusts

In rare cases, damaged electrical components can cause formation of toxic chemicals inside the inverter, in such presence of substances, gases or dusts. Exposure or inhaling such chemical may result in poisoning, skin irritation or burns, breathing difficulty and nausea.

- Personal protective equipment **MUST** be worn suitably and properly for all work.

WARNING

Danger to life due to fire or explosion

In rare cases, operating under fault conditions may generate gas mixture inside any electrical devices, that can be explosive or inflammable while switching operational state (e.g. switching the product ON/OFF in a ground fault event). Flying debris from the fire or explosion may result in death or severe injuries.

- **DO NOT** work the DC Switch on the product in the event of ground fault.
- Before working on the product, voltage resources **MUST** be disconnected and fully de-energized.
- PV arrays **MUST** be disconnected using a disconnection device instead of bare hands.
- AC circuit breaker (if any) **MUST** be disconnected.

! CAUTION

Risk of injury and property damage due to inappropriate modifications or technical specifications

Modifications or alterations to the product and its connected system are not allowed unless with written permission of NEP. Unauthorized modifications may cause incompliance with product's technical requirement (e.g. maximum input voltage or current), that may result in moderate or minor injuries, and property damages.

- Any guarantee and warranty claims in such cases will be voided.

! CAUTION

Risk of injury due to hot enclosures

Touching parts of product enclosure that may get hot during operation (e.g. heatsink) and may result in burn injuries.

- **DO NOT** touch any parts other than the cover lid of the product.
- Before working on the product, voltage resources **MUST** be disconnected, and leave the product to cool down for 30 minutes.

! CAUTION

Risk of injury due to weight of product

Lifting the product incorrectly or dropping in transportation or mounting may result in injuries like bruises or muscle strains.

- Make sure to take the weight of product into account in transportation and lifting, and proceed carefully.
- To avoid muscle strain or injury, please use proper lifting techniques and any necessary aid/tools.
- Personal protective equipment **MUST** be worn suitably and properly for all work.

! NOTICE

Damage to product and property due to wrong output type

The product described in this document is designed to directly tie with and feed power into public utility power grid. Connecting the product in any other forms of AC output source or equipment may result in product and property damage.

- **DO NOT** connect AC output of the product to any other sources than the utility grid, which will otherwise void any guarantees and warranty claims.
-

NOTICE

Damage to product due to aggressive cleaning agents

For purpose of cleaning, using aggressive chemicals and cleaning agents may cause damage to the product and components.

- Use a wet cloth with clear water to clean the product.
-

INFORMATION

The product must **ONLY** be connected and operated with PV arrays of protection class II, in accordance with IEC 61730, application class A. The PV modules must also be compatible with this product. Power sources other than compatible PV arrays **MUST** not be connected and operate with the product.

OVERVIEWING THE PRODUCT

Product Overview

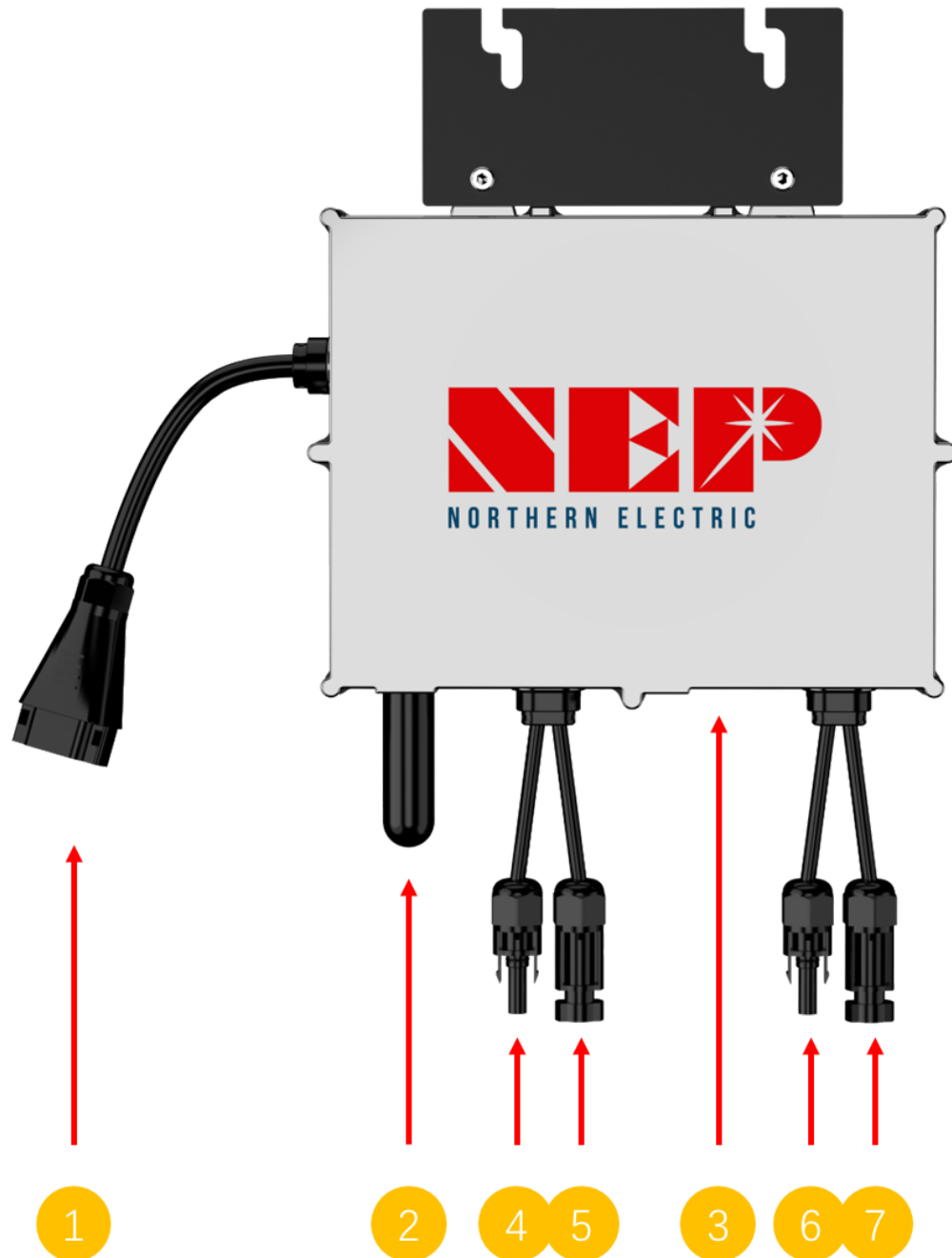

1	AC Output Terminal
2	WiFi Dongle (optional)
3	LED display
4	DC input 1 (+)
5	DC input 1 (-)
6	DC input 2 (+)

7	DC input 2 (-)
---	----------------

Identifying the Product

Serial Number (S/N)







SN is on the sticker which place right bottom corner of the product.

Symbols on the label

INFORMATION

INFO denotes information that is important but non safety-relevant for a task or topic.

Label is located on the side of the inverter. The information on the label includes technical data as well as type and serial number of the device. Safety instructions are listed and explained below:

	<p>Danger!</p> <p>The term “danger” describes an issue which, if ignored can cause personal injury.</p>
	<p>Attention!</p> <p>With the term “attention” a circumstance is listed which may cause property damage if disregarded.</p>
	<p>Instructions for use!</p> <p>Under “Instructions for Use”, it is pointed out that installation and operating instructions are to be read and understood before installation or repair.</p>
	<p>Caution, hot surface!</p> <p>Under “Caution, hot surface”, it should be noted that surfaces of equipment may be hot and create a burn hazard.</p>
	<p>Special disposal instructions!</p> <p>With “Note Separate Disposal”, it is pointed out that this product may not be disposed of with normal garbage. An improperly conducted disposal can lead to damage to the environment.</p>
	<p>CE mark</p> <p>The product complies with essential requirements of relevant directives of EU</p>

INSTALLING THE PRODUCT

Safety

WARNING

Danger to life due to fire or explosion

All electrical devices can cause fires despite careful construction. Flying debris from the fire or explosion may result in death or severe injuries.

- **DO NOT** install the product in environment with any flammable materials or gases.
- **DO NOT** install the product in environment with any potentially explosive items or gases.

CAUTION

Risk of injury due to weight of product

Lifting the product incorrectly or dropping in transportation or mounting may result in injuries like bruises or muscle strains.

- Make sure to take the weight of product into account in transportation and lifting, and proceed carefully.
- To avoid muscle strain or injury, please use proper lifting techniques and any necessary aid/tools.
- Personal protective equipment **MUST** be worn suitably and properly for all work.

CAUTION

Risk of injury due to cables routed in wall

Drilling holes on a wall may damage power cables or pipes for gas or water routed inside.

- Make sure to take cables or pipes into account before drilling.
- Personal protective equipment **MUST** be worn suitably and properly for all work.

INFORMATION

Risk of shortened product lifespan due to inappropriate installation environment

Installing the product in an inappropriate environment may risk shortening its lifespan. To ensure optimal performance and operation, please:

- **DO NOT** install the product in exposure to direct sunlight.
- **DO NOT** install the product in exposure to rain and snow.
- **DO NOT** install the product in exposure to splash of salt water.
- Make sure the installation site meets ventilation requirement of the product.

INFORMATION

The pollution degree of the external environment for NEP's inverters is **PD3**.

Pollution Degree 3 indicates:

Conductive pollution occurs, or dry, non-conductive pollution occurs which becomes conductive due to condensation which is expected.

INFORMATION

Lightning Surge Suppression

Lightning does not actually need to strike the equipment or building where PV system is installed to cause damage. Often, a strike nearby will induce voltage spikes in the electrical grid that can damage equipment. Micro inverter has integrated surge protection, greater than most string inverters. However, if the surge has sufficient energy, the protection built into the micro inverter can be exceeded, and the equipment can be damaged.

Since the NEP Limited Warranty does not cover “acts of God” such as lightning strikes, and since lightning strikes can occur anywhere, it is best practice to install surge protection as part of any solar installation. Installation of surge protection devices should follow vendor instructions.

Parts required

In addition to the micro inverters, PV modules, racking, and associated hardware, you'll need the micro inverter installation kit. This kit includes the following items:

- Protective end cap Male
- Mounting Bracket (adapter plate)

Other Parts and Tools Required

In addition to your PV array and its associated hardware, you will need the following parts:

- Junction box
- Sockets, wrenches for mounting hardware

Procedure of Mounting

1. Measuring service and installing the AC branch circuit junction box.

WARNING

ONLY USE ELECTRICAL SYSTEM COMPONENTS APPROVED FOR WET LOCATIONS.

2. Attaching the micro inverter Micro inverter to the racking.
3. Connecting the micro inverter Micro inverter wiring harnesses.
4. Grounding the system (optional).

DC circuits of micro inverter are isolated and insulated from ground. An integrated ground protection circuit is included in the micro inverter.

5. Completing the micro inverter Micro inverter installation map and connecting the PV modules.

The finished system should be similar as in the diagram.

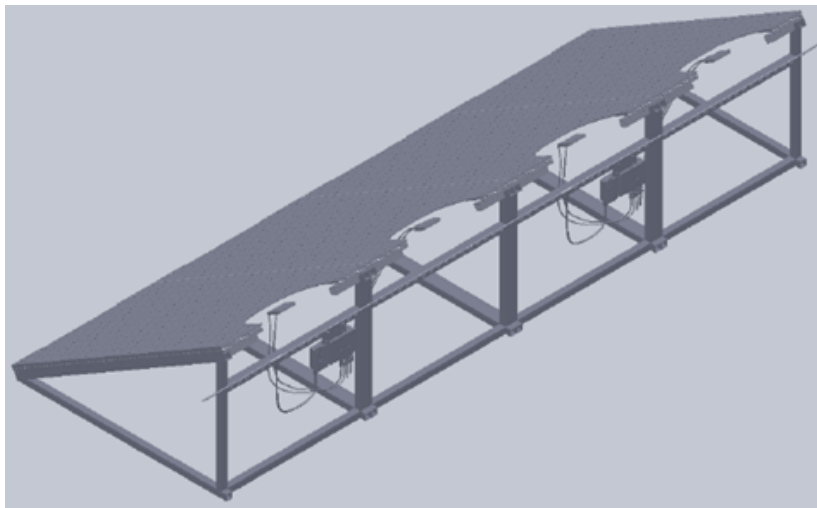

i INFORMATION

To only install one inverter or **BALCONY SOLUTION**

Please follow the sign



CONNECTING THE PRODUCT

Safety: Electrical Connections

DANGER

Danger to life due to electric shock

DO NOT touch any live component.

TO prevent risk of electric shock during installation and maintenance, please make sure that the AC and DC inputs are plugged out. **DO NOT** stay close to the instruments while there is severe weather conditions including storm, lightning etc.

AC Connection

STEP 1 - Install the AC Branch Circuit Junction Box

Measure service entrance conductors to confirm AC service at the site. Acceptable ranges are differ according to local grid parameter, specifics are shown in the table below:

- North America
 - 240 Volt AC Single Phase

L1 to L2	240 V_{ac}
-----------------	---------------------------

- 208 Volt AC Three Phase

L1 to L2	208 V_{ac}
-----------------	---------------------------

- Australia and New Zealand

L1 to L2	230 V_{ac}
-----------------	---------------------------

- Europe

L1 to L2	230 V_{ac}
-----------------	---------------------------

Mount the adapter plate at a suitable location on the PV racking system (typically at the end of a row of modules).

Install an appropriate junction box with the adapter plate.

Connect the open wire end of the AC interconnect cable into the junction box using an appropriate gland or strain relief fitting. The AC interconnect cable requires a strain relief connector with an opening of 3/8 inches in diameter.

STEP 2 - Attach product to the Racking

Mark the approximate centers of each PV module on the racking system. Evaluate the location of the micro inverter with respect to the PV module junction box or any other obstructions.

WARNING

ALLOW A MINIMUM OF .75 INCHES BETWEEN THE TOP OF THE ROOF AND THE BOTTOM OF micro inverter. WE ALSO RECOMMEND THAT YOU ALLOW .50 INCHES BETWEEN THE BACK OF THE PV MODULE AND THE TOP OF micro inverter. DO NOT MOUNT micro inverter IN A LOCATION THAT ALLOWS LONG-TERM EXPOSURE TO DIRECT SUNLIGHT.

Mount one micro inverter at each of these locations using hardware recommended by your module racking vendor

STEP 3 - Inter-connect Micro inverters into branch

Each product comes with one AC output cable with T-connection connector at the end. Plug the AC connector of the each product into socket on the Trunk Cable to form a continuous AC branch circuit. Please check the rating label of the trunk cable for the maximum allowable number of products on one AC branch circuit.

WARNING

DO NOT EXCEED THE MAXIMUM NUMBER OF MICRO INVERTERS IN AN AC BRANCH CIRCUIT, AS DISPLAYED ON THE UNIT-RATING LABEL. For 12AWG trunk cable, EACH AC BRANCH CIRCUIT MUST BE SOURCED FROM A DEDICATED BRANCH CIRCUIT PROTECTED BY A 20A MAXIMUM BREAKER.

Install a protective end cap on the open AC connector at the end of the branch.

INFORMATION

NEP micro inverters are designed to be able to inter-connect with other NEP micro inverter models.

WARNING

MAKE SURE PROTECTIVE END CAPS HAVE BEEN APPLIED ON ALL UNUSED AC CONNECTORS.

MAKE SURE PROTECTIVE END CAPS HAVE BEEN APPLIED ON THE END OF TRUNK CABLE.

BALCONY
SOLUTION

Typical Balcony Solution Topology

INFORMATION

For Balcony Solution products, the AC output terminals are customized and different from standard issue products.

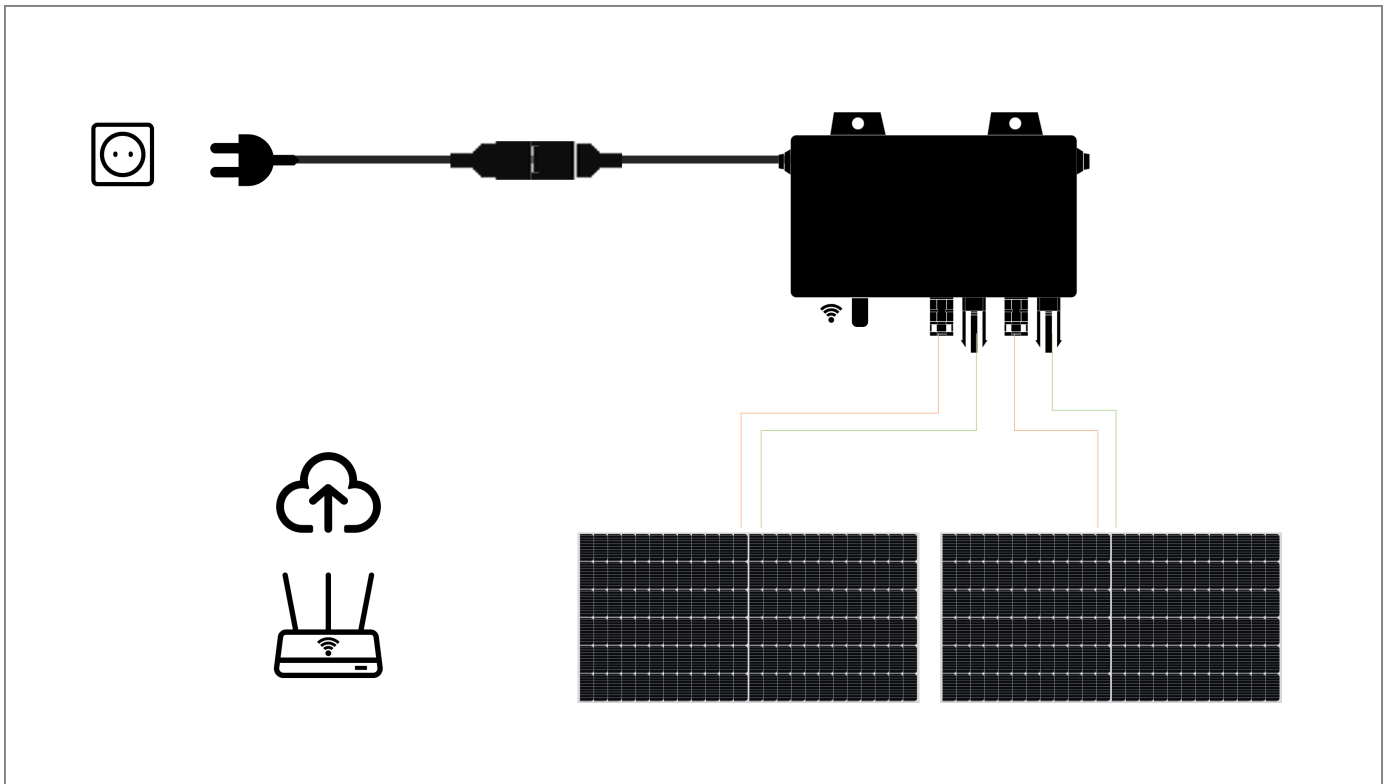

For balcony solution, there is only one inverter in the system. The monitoring is realized by WIFI connection between WiFi dongle on the inverter and home router.

TRUNK CABLE

Typical Trunk Cable Topology

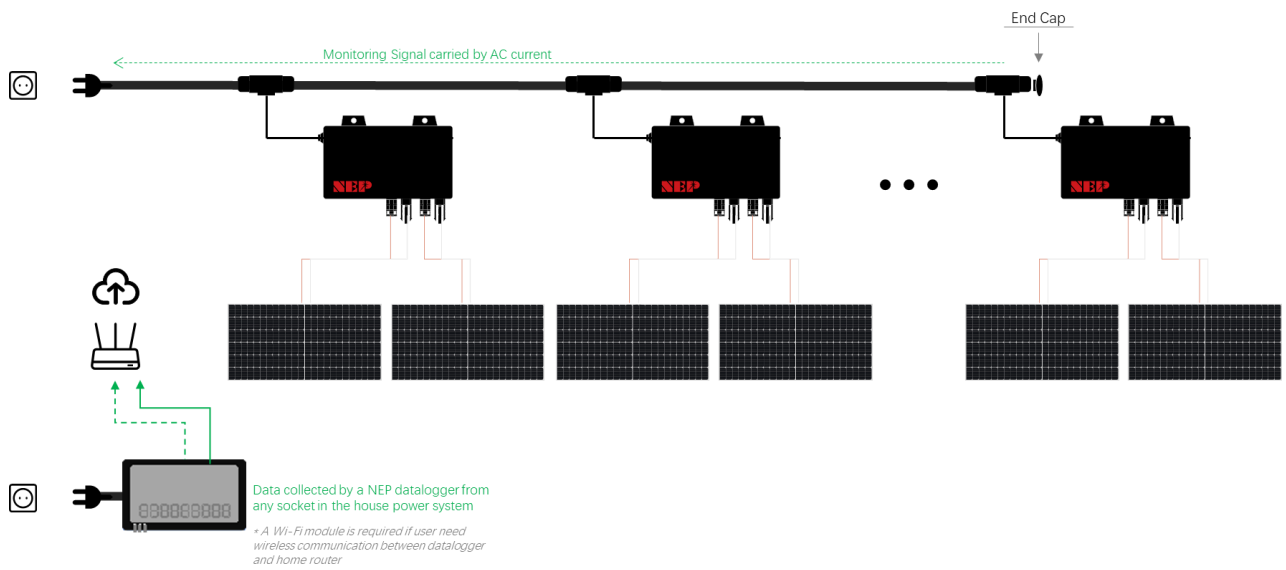

STEP 4 – Ground the system

Each product has an integrated ground protection circuit. The grounding wire is through the trunk cable, and should be securely connected to the ground connector in the junction box.

STEP 5 - Ground the system through racking (option)

BDM-800 may also be grounded through the racking.

STEP 6 - Complete the connection map and connect the PV Modules

A connection map is a diagrammatic representation of the physical location of each micro inverter in your PV installation. The virtual array in NEP micro inverter gateway BDG-256 is created from the map you create. It will be handy when installing multiple products.

Each product has a removable serial number label located on the mounting plate. Enter this serial number into the BDG-256, and correspond it to a number in the connection map.

DC Connection

Safety: Connecting DC

DANGER

Danger to life due to electrical shock when live DC cables or components are touched

High DC voltages are present in the DC cables when PV modules are exposed to light. Touching live DC cables or components may result in death or severe injuries due to electric shock.

- **DO NOT** touch non-insulated parts or cables.
- **DO NOT** touch live components when voltage sources are still connected or just disconnected.
- **DO NOT** connect DC connectors to the product under load.
- Personal protective equipment **MUST** be worn suitably and properly for all work on the product and the system.
- Voltage sources **MUST** be disconnected from the product before all work.

DANGER

Danger to life due to electrical shock from touching ungrounded components or from touching live components in case of a ground fault

Touching ungrounded PV modules, array frame, inverter or live system component, or parts of the system components that are still live in the event of a ground fault, may result in death or severe injuries due to electric shock.

- PV modules and the array frames, including electrically conductive surfaces, **MUST** be connected and grounded in compliance with all applicable regulations.

In the event of a ground fault,

- **DO NOT** touch any parts or frame of the PV array.
- **DO NOT** touch any cables without reliable insulation.
- **DO NOT** connect the product to any strings with ground faults.
- Before working on the product, voltage resources **MUST** be disconnected.

- Personal protective equipment **MUST** be worn suitably and properly for all work.

! CAUTION

Risk of injury and property damage

In connection of DC cables to the inverter, maximum input current and voltage **MUST** not exceed permitted range as stated in [Product Parameters](#).

- Any guarantee and warranty claims in such cases will be voided.

Requirements for PV Modules

- All PV modules of connected arrays should be of the same type.
- All PV modules of connected arrays should be aligned properly and tilted identically.
- **DO NOT** parallel modules in one string of DC input.
- In connection of each independent MPPT, PV arrays in parallel connection should have the same number of modules.
- Max. input voltage and current per string
- For connection of PV modules to the inverter, all PV modules **MUST** be fitted with the supplied DC connectors.
- When assembling the DC connectors, cables **MUST** be equipped with DC connectors of the correct polarity.
 - e.g. **[positive]** connection cable to **[positive]** DC connectors, **[negative]** connection cable to **[negative]** DC connectors.
- Before connecting the PV modules to the inverter, the inverter's DC switch **MUST** be switched **OFF**.
- The DC input voltage AND DC input current of the PV array **MUST** never exceed the maximum input voltage and current of the inverter.

DC Connection Procedure

Completely install all micro inverter and all system inter-wiring connections prior to installing the PV modules.

1. Mount the PV modules above their corresponding micro inverter. Each micro inverter comes with two oppositely sexed DC connectors.
2. First connect the positive DC wire from the PV module to the negatively marked DC connector (male pin) of the micro inverter. Then connect the negative DC wire from the PV module to the positively marked DC connector (female socket) of the micro inverter. Repeat for all remaining PV modules using one micro inverter for each module.

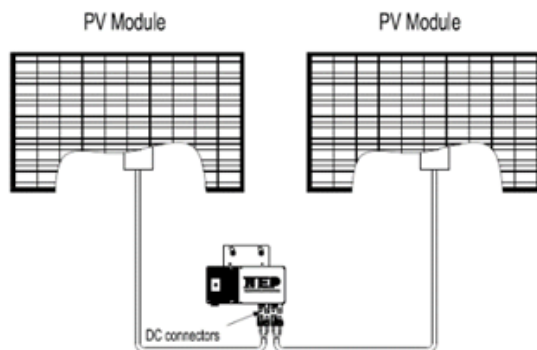

Removing DC

Safety: Disconnection

DANGER

Danger to life due to electrical shock when live components are touched in opened product

High voltages and energies are present in live components and cables inside the product during operation, e.g. capacitors, connectors. Touching live components and cables may result in death or severe injuries due to electric shock.

- **DO NOT** open the product.
- **DO NOT** touch live components.

The product **MUST ONLY** be opened for maintenance reasons by a qualified person, after

- both DC and AC switches or isolators, if any, externally connected or integrated, are switched to OFF
- both DC and AC connections are plugged out
- voltages inside the product are fully discharged

DANGER

Danger to life due to electrical shock when live DC cables or components are touched

High DC voltages are present in the DC cables when PV modules are exposed to light. Touching live DC cables or components may result in death or severe injuries due to electric shock.

- **DO NOT** touch non-insulated parts or cables.
- **DO NOT** touch live components when voltage sources are still connected or just disconnected.
- **DO NOT** connect DC connectors to the product under load.
- Personal protective equipment **MUST** be worn suitably and properly for all work on the product and the system.
- Voltage sources **MUST** be disconnected from the product before all work.

CAUTION

Risk of injury due to weight of product

Lifting the product incorrectly or dropping in transportation or mounting may result in injuries like bruises or muscle strains.

- Make sure to take the weight of product into account in transportation and lifting, and proceed carefully.
- To avoid muscle strain or injury, please use proper lifting techniques and any necessary aid/tools.
- Personal protective equipment **MUST** be worn suitably and properly for all work.

Procedure of Disconnecting



QUALIFIED PERSONS

Before any work on the disconnection of the inverter, **ALWAYS** disconnect it from all voltage sources in the described sequence as following.

1. Disconnect the AC by opening the branch circuit breaker.
2. Disconnect the first AC connector in the branch circuit.
3. Cover the module with an opaque cover.
4. Using a DC current probe, verify there is no current flowing in the DC wires between the PV module and the micro inverter.
5. Care should be taken when measuring DC currents, most clamp-on meters must be zeroed first and tend to drift with time.
 - **Do not pull on the cable.**
 - Instead, use the disassembly tool for PV connectors at the point of interconnection of female and male connectors.
 - Pull out the connectors in a downward direction.



6. Use a suitable measuring device to ensure that **no voltage** is left at the DC inputs of the inverter.
7. Disconnect the PV module DC wire connectors from the micro inverter.
8. Remove the micro inverter from the PV array racking.
9. Use a suitable measuring device to ensure that **no voltage** is left at the AC inputs.
 - Measure the voltage by inserting the probe to the opening of each terminal.
 - Check the voltages between L and N, and between L and PE.
10. If necessary, remove the M5 screw securing the inverter to mounting bracket. Lift the inverter from the mounting bracket.

Dispose of the inverter should be in accordance with disposal regulations for electronic waste. Refer to [Recycling and Disposal](#).

Re-install micro inverter

1. Attach the replacement micro inverter to the PV module racking using hardware recommended by your module racking vendor
2. Connect the AC cable of the replacement micro inverter and the neighboring micro inverter to complete the branch circuit connections.
3. Complete the connection map and connect the PV Modules.
 1. Complete the connection map
 2. Each micro inverter has a removable serial number located on the mounting plate. Enter this serial number into a BDG-256, and correspond it to a number in the connection map.

3. Connect the PV Modules
4. Completely install all micro inverter and all system inter-wiring connections prior to installing the PV modules.
 1. Mount the PV modules above their corresponding micro inverter. Each micro inverter comes with two oppositely sexed DC connectors.
 2. First connect the positive DC wire from the PV module to the negatively marked DC connector (male pin) of the micro inverter. Then connect the negative DC wire from the PV module to the positively marked DC connector (female socket) of the micro inverter. Repeat for all remaining PV modules using one micro inverter for each module.
4. Replace the old PLC_ID in the BDG-256 gateway with the new PLC_ID of the replacement micro inverter.

COMMISSIONING

WARNING

CONNECT micro inverter TO THE ELECTRICAL UTILITY GRID ONLY AFTER RECEIVING PRIOR APPROVAL FROM THE UTILITY COMPANY.

WARNING

BE AWARE THAT ONLY QUALIFIED PERSONNEL CAN CONNECT micro inverter TO THE ELECTRICAL UTILITY GRID.

WARNING

ENSURE THAT ALL AC AND DC WIRING IS CORRECT. ENSURE THAT NONE OF THE AC AND DC WIRES IS PINCHED OR DAMAGED. ENSURE THAT ALL JUNCTION BOXES ARE PROPERLY CLOSED.

Monitoring Configuration

WiFi configuration

NOTICE

DO NOT CONNECT AC

In the state of DC connected, AC disconnected, AP mode of the microinverter will be activated.

If AC connected by accident, please unplug AC, DC to wait for memory clearance of the microinverter.





NOTICE

Find the AP Number

An eight-digit string can be found under the barcode on the sticker.
This is the **AP Number**



Get and Open NEPViewer

Obtain NEPViewer App	
	<p>Available on the  App Store  Google Play</p> <p>Search for NEPViewer in App Store or Google Play</p> <p>* Android users can visit user.nepviewer.com for latest version APK file</p>
Open NEPViewer	

Add inverter to NEPViewer

Login or Register



Email

Password

Confirm Password

Name

Contact number

Country/Region

[Create New Account](#) [Reset Password](#)

Sign in

Register Now

Create a new site
Enter the required information

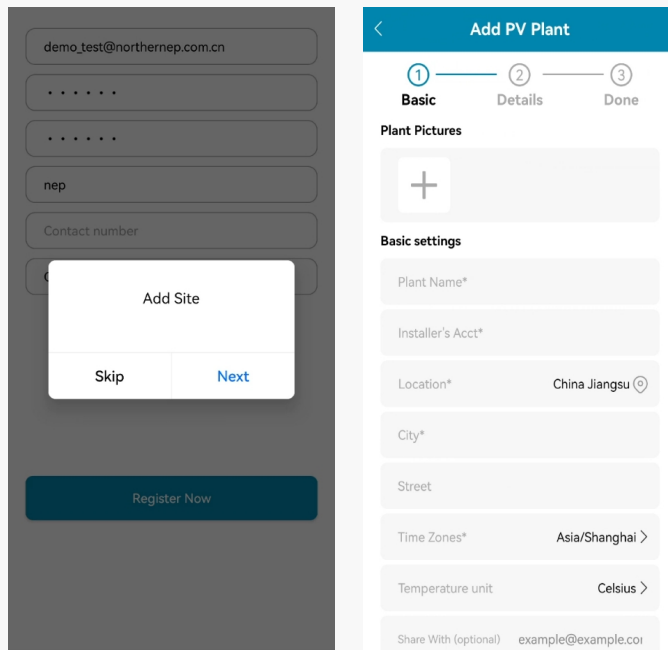

demo_test@northernep.com.cn

.....

.....

nep

Contact number

Add Site

Skip **Next**

Register Now

Add PV Plant

1 — 2 — 3

Basic Details Done

Plant Pictures

+

Basic settings

Plant Name*

Installer's Acct*

Location* China Jiangsu

City*

Street

Time Zones* Asia/Shanghai

Temperature unit Celsius

Share With (optional) example@example.com

If you're using a No-WiFi device (PLC communication), select Gateway, then enter the SN Code and click Next.
 If you're using a WiFi device, select BDM-WiFi, then follow the following tutorial for WiFi Configuration.

On label of the inverter, a serial number can be found under the bar code, in form of:
 XXXXX-XXXXXXXX-X

Continue to configure WiFi

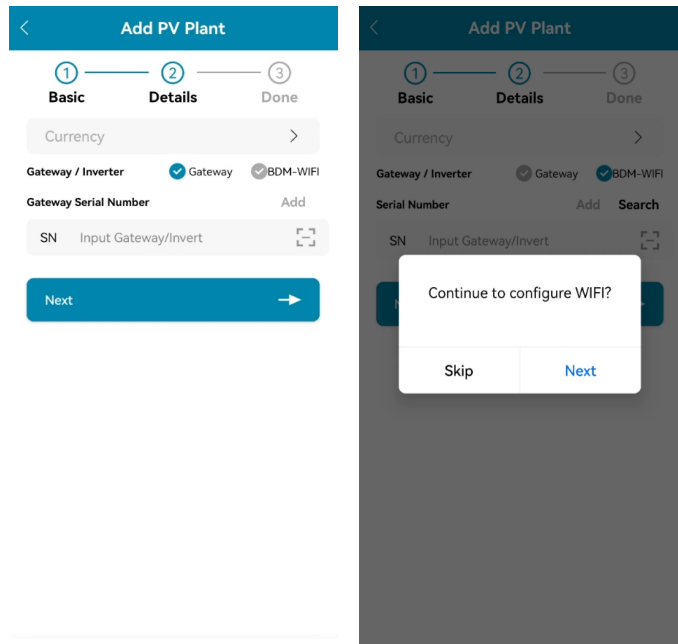

For IOS

For Click **Allow** to obtain geographic location permission (only pops up when installing the app for the first time)IOS

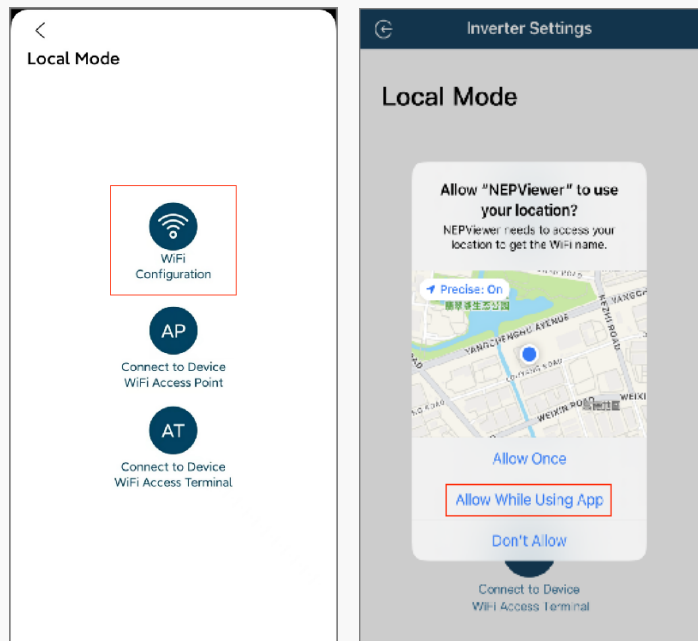

Enter the home WiFi name and password

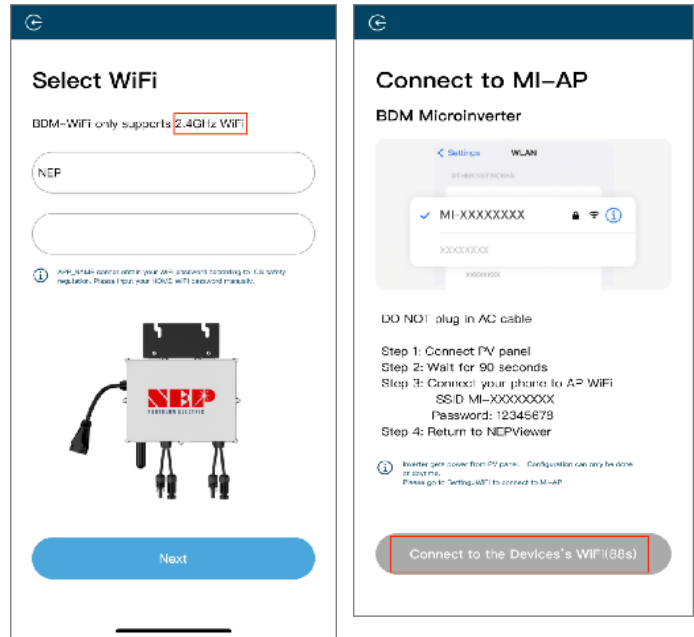

Connect to the hotspot SSID: MI-XXXXXXX
Password: 12345678
Return to NEPViewer app

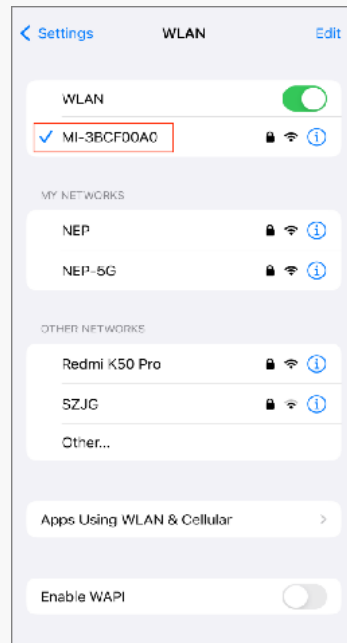

Allow connection to local network (It will pop up only when the app is installed for the first time)

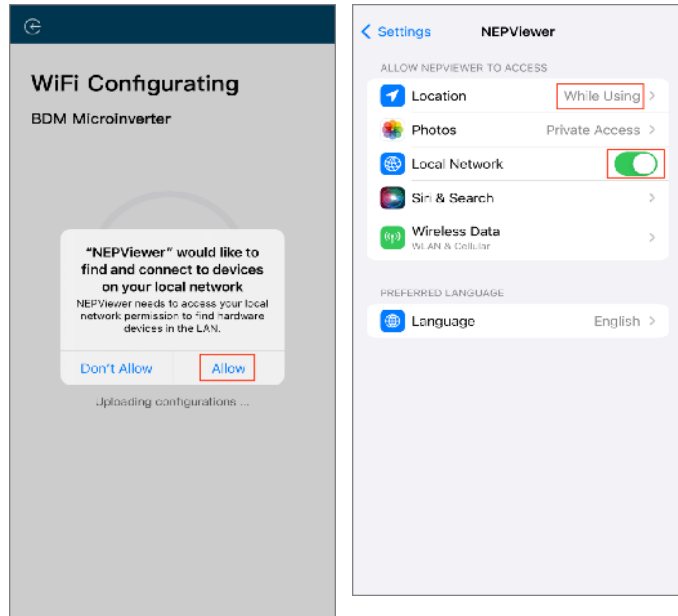

Click the button to check the connectivity

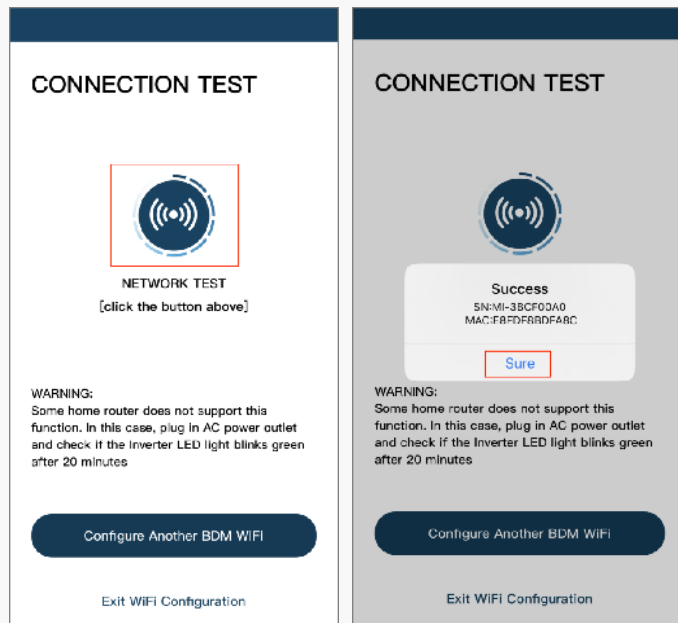

For Android

Enter the home WiFi name and password

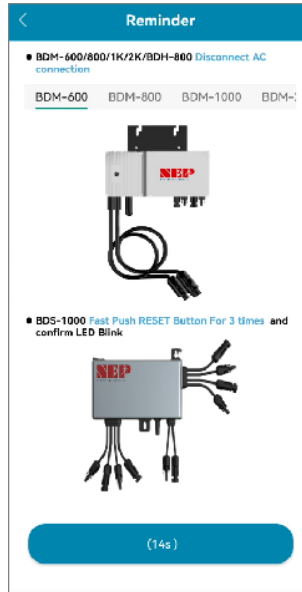

Select the device that requires WiFi configuration

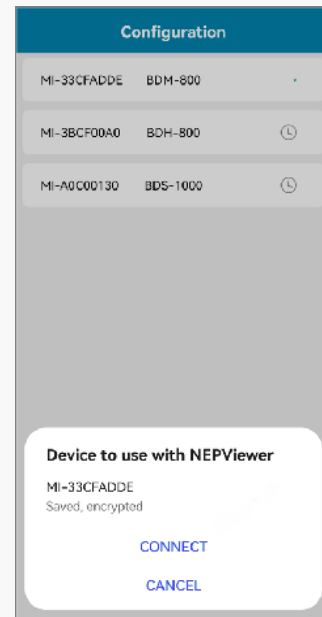
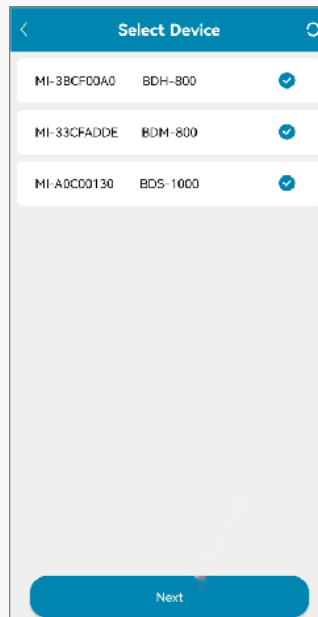

When there is a failed device, the **Retry** button will appear for easy re-networking. Click **TEST** to go to the connectivity test page.

Successful connectivity detection will display the **IP address**.

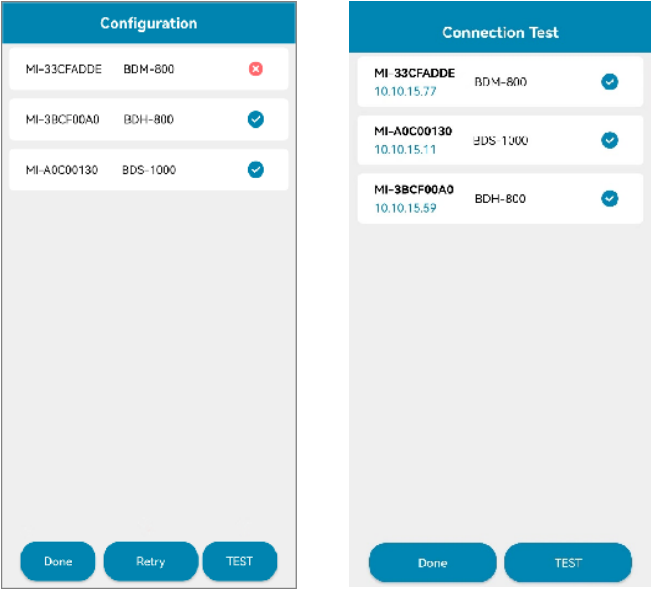

It's all set!
Enjoy your PV freedom!

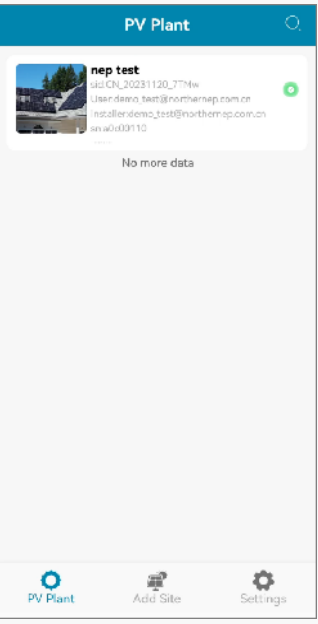

Start Power Generation

Following these steps to commission the micro inverter PV system:

1. Turn on the AC disconnects or circuit breakers on each micro inverter AC branch circuit.
2. Turn on the main utility-grid AC circuit breaker. Your system will start producing power after a few minutes wait time.
3. The micro inverter will start to send performance data over the power lines using power line communication (PLC) to the BDG-256. The time required for each micro inverter in the system to communicate to the BDG-256 will vary with the number of micro inverter in the system.

Operating Instructions

The micro inverter is powered on when sufficient DC voltage from the module is applied. The status LED will start flashing after sufficient DC power is applied as an indication that the micro inverter is live.

LED	Status	Meaning
Green Light Flashing every two seconds	Standby	OK
Red Light Flashing every two seconds	Standby	Error
Orange Light Flashing every two seconds	Standby	no communication with BDG-256
Green Light Flashing every one seconds	Producing	Standby
Red Light Solid	Producing	Grounding Fault
Orange Light Flashing every one seconds	Producing	no communication with BDG-256

TROUBLESHOOTING

In case of fault, BDM inverter has multiple protective functions and stops output power. The fault message may be sent to a connected BDG-256 gateway through power line communication. For BDM-WiFi, the same alert is sent through WiFi internet connection, and can be monitored through NEPViewer (please refer to the tech note "Configuring BDM WiFi"). The alert message is a 16-bit code.

Error code	Error
Bit-0	DC over voltage
Bit-1	DC under voltage
Bit-2	hardware error
Bit-3	Inverter over voltage
Bit-4	Frequency over
Bit-5	Frequency under
Bit-6	AC voltage RMS over
Bit-7	AC voltage RMS under
Bit-8	Peak AC voltage over
Bit-9	AC current RMS over
Bit-10	Peak AC current over
Bit-11	Temperature over
Bit-12	ADC error
Bit-13	GFDI fault indicator
Bit-14	Relay fault
Bit-15	PLC Communication Error

WARNING

DO NOT ATTEMPT TO REPAIR THE micro inverter; IT CONTAINS NO USER-SERVICEABLE PARTS. IF TROUBLESHOOTING METHODS FAIL, PLEASE RETURN THE micro inverter TO YOUR DISTRIBUTOR FOR MAINTENANCE.

WARNING

NEVER DISCONNECT THE DC WIRE CONNECTORS UNDER LOAD. ENSURE THAT NO CURRENT IS FLOWING IN THE DC WIRES PRIOR TO DISCONNECTING. AN OPAQUE COVERING MAY BE USED TO COVER THE MODULE PRIOR TO DISCONNECTING.

WARNING

PRODUCT IS POWERED BY DC POWER FROM PV MODULES. MAKE SURE YOU DISCONNECT THE DC CONNECTIONS AND RECONNECT DC POWER TO WATCH FOR THE TWO SECONDS LED ON AND TWO SECONDS LED OFF AFTER DC IS APPLIED.

WARNING

ALWAYS DISCONNECT AC POWER BEFORE DISCONNECTING PV MODULE WIRES FROM micro inverter. THE AC CONNECTOR OF THE FIRST micro inverter IN A BRANCH CIRCUIT IS SUITABLE AS A DISCONNECTING MEANS ONCE THE AC BRANCH CIRCUIT BREAKER IN THE LOAD CENTER HAS BEEN OPENED.

Troubleshooting an inoperable BDM micro inverter

To troubleshoot an inoperable micro inverter, follow the steps in the order shown:

1. Check the connection to the utility grid. Verify that the utility voltage and frequency are within allowable ranges shown in the label of micro inverter.
2. Verify utility power is present at the inverter in question by removing AC, then DC power. Never disconnect the DC wires while the micro inverter is producing power. Re-connect the DC module connectors, and then watch for the LED blinks.
3. Check the AC branch circuit interconnection harness between all the micro inverter. Verify that each inverter is energized by the utility grid as described in the previous step.
4. Make sure that any AC disconnects are functioning properly and are closed.
5. Verify the PV module DC voltage is within the allowable range shown in the label of micro inverter.
6. Check the DC connections between the micro inverter and the PV module.
7. PLC signal quality may be checked through the interface on the BDG-256 gateway. If the PLC signal is weak, it might be due to the distance between the micro inverters and the gateway. It may also be caused by the interference from other electronic devices. In most cases, signal quality may be significantly improved by moving the BDG-256 to closer to the micro inverter arrays, and/or farther away from other interferers. In some cases, a signal filter (LCF) may be installed to reduce the interference to PLC communication. If there are two or more separate BDM systems close by, it is highly recommended to install LCF for each micro inverter system to block interference from adjacent other systems.
8. If the problem persists, please call customer support at NEP.

WARNING

DO NOT ATTEMPT TO REPAIR THE micro inverter; IT CONTAINS NO USER-SERVICEABLE PARTS. IF TROUBLESHOOTING METHODS FAIL, PLEASE RETURN THE micro inverter TO YOUR DISTRIBUTOR FOR MAINTENANCE.

RECYCLING AND DISPOSAL

NOTICE



In requirement of WEEE, dispose the product using methods that are in accordance with local

 regulations for electronic waste

The product described in this document is involved and categorized in the regulations of **Waste Electrical and Electronic Equipment (WEEE)** from the **European Community Directive 2012/19/EU**. Such regulations shall be applied in dispose and recycle of the product.

In countries and regions where equivalent regulations to WEEE are implemented in dispose of electrical and electronic waste, disposing methods in accordance with all applicable laws should be taken.

- If the product is to be stored away or shipped, pack the inverter using the original packaging or packaging that is suitable for the weight and dimensions of the product.
- If the product is no longer required or that replacement of the product is arranged or is to be arranged:
 - **DO NOT** dispose of the product together with the household waste.
 - Inform your dealer of the product or an authorized partner of NEP with information of the disposing product.
 - Dispose the product to a suitably authorized facility for recycling of electrical and electronic waste.

PRODUCT PARAMETERS

Input | DC

Model		BDM-800
Recommended PV Module Power Range	W	600 x 2
MPPT Voltage Range	V	22-55
Startup Voltage	V	24
Max. Input Voltage	V	60
Max. Input Current	A	17 x 2
Overvoltage Protection Category		II

Output | AC

Model		BDM-800
Peak Output Power	VA	800
Max. Continuous Output Power	VA	750
Rated Output Voltage	V	230
Nominal Output Voltage Range	V	Configurable
Max. Continuous Output Current	A	3.26
Nominal Frequency / Range	Hz	50 / Configurable
Power Factor (Nominal/Adjustable Range)		1.0/0.8 leading...0.8 lagging
AC Short Circuit Fault Current Over 3 cycles	Arms	8.2
THDi@Rated Power		<3%
Max. Units per 20A Branch		5
Overvoltage Protection Category		III

Efficiency

Model		BDM-800
Peak Efficiency		97.3%
MPPT Efficiency		>99.5%
Night Power Consumption	mW	110
Relative Humidity Range		0-100%
Dimensions (W x H x D)	mm	268 x 250 x 42
Weight	kg	2.9
DC Connector Type		MC4
AC Connection Type (inverter-inverter)		Trunk Cable
Communication Method		PLC or WiFi
Protection Class		NEMA-6 / IP-66 / IP-67

The AC voltage/Frequency range may vary depending on specific country grid